

FIELDMASTER®

OWNER S/
OPERATOR S
MANUAL

MODEL NO. s

SBX-4

SBX-5

SBX-5½

SBX-6

SBX-7

SBX-8

⚠ CAUTION

For Safe Operation
Read Rules And
Instructions Carefully

SINO LEEINGLES, PIDA AYUDA
A AIGUIEN QUE SI LO LEA
PARA QUE LE TRADUZCA LAS
MEDIDAS DE SEGURIDAD.

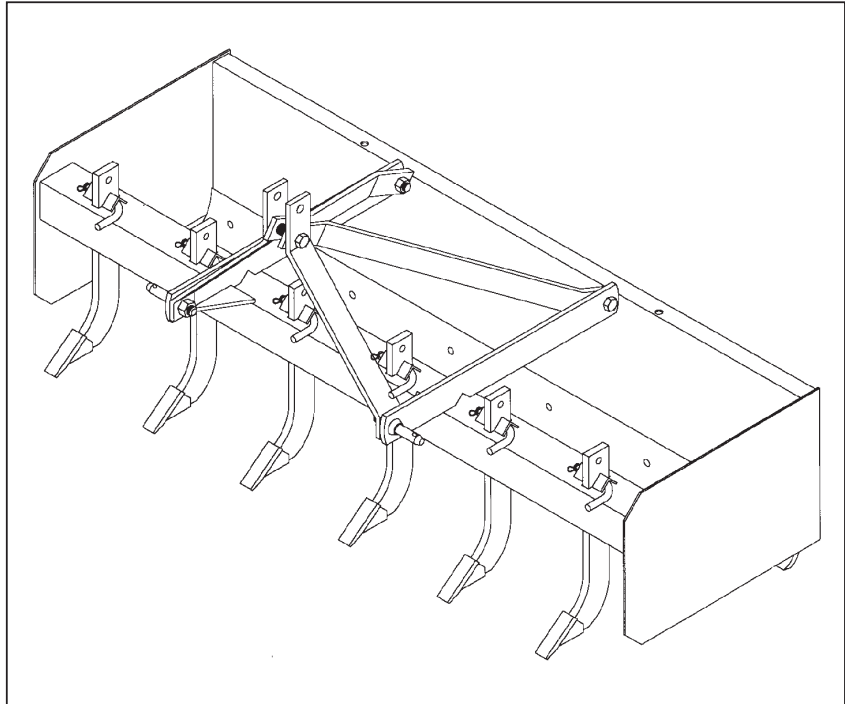

3 PT. BOX SCRAPER

Safety Instructions
Tractor Preparation
Operating Instructions

Assembly & Mounting
Maintenance
Repair Parts

⚠ CAUTION

**THE FOLLOWING SAFETY PRECAUTIONS SHOULD BE THOROUGHLY UNDERSTOOD
BEFORE ATTEMPTING TO BEGIN ASSEMBLING THIS MACHINE**

1. Select an area for assembly that is clean and free of any debris which might cause persons working on the assembly to trip.
2. Do not lift heavy parts or assemblies. Use crane, jack, tackle, fork trucks or other mechanical devices.
3. Preview the assembly instructions in your operator s manual before proceeding further.
4. If the assembly instructions call for parts or assemblies to be blocked up, use only blocking material that is in good condition and is capable of handling the weight of the assembly to be blocked. Also insure that the blocking material is on a clean, dry surface.
5. Never put hands, or any part of body, under blocked up assemblies if at all possible.
6. After completing assembly, thoroughly inspect the machine to be sure that all nuts, bolts, hydraulic fittings or any other fastened assemblies have been thoroughly tightened.
7. Before operating the machine, thoroughly read the operation section of your operator s manual.
8. Before operating, read the maintenance section of your operator s manual to be sure that any parts requiring lubrication, such as gearboxes, are full, to avoid any possible damage.
9. **Before operating equipment – If you have any questions regarding the proper assembly or operation, contact your dealer or representative.**

To the Owner/Operator/Dealer

All implements with moving parts are potentially hazardous. There is no substitute for a cautious, safe-minded operator who recognizes the potential hazards and follows reasonable safety practices. The manufacturer has designed this implement to be used with all its safety equipment properly attached to minimize the chance of accidents.

BEFORE YOU START!!

Read the safety messages on the implement and shown in your manual.

Observe the rules of safety and common sense!



THIS SYMBOL MEANS

– ATTENTION!

– BECOME ALERT!

– YOUR SAFETY IS INVOLVED!

THIS SAFETY ALERT SYMBOL IDENTIFIES IMPORTANT SAFETY WARNING MESSAGES. CAREFULLY READ EACH WARNING MESSAGE THAT FOLLOWS. FAILURE TO UNDERSTAND AND OBEY A SAFETY WARNING, OR RECOGNIZE A SAFETY HAZARD, COULD RESULT IN AN INJURY OR DEATH TO YOU OR OTHERS AROUND YOU. THE OPERATOR IS ULTIMATELY RESPONSIBLE FOR THE SAFETY OF HIMSELF, AS WELL AS OTHERS, IN THE OPERATING AREA OF THE TRACTOR AND ATTACHED EQUIPMENT.

UNDERSTAND SIGNAL WORDS

Note the use of the signal words **DANGER**, **WARNING** and **CAUTION** with the safety messages. The appropriate signal word for each has been selected using the following guidelines:

DANGER: Indicates an imminently hazardous situation that, if not avoided, will result in death or serious injury. This signal word is to be limited to the most extreme situations typically for machine components which, for functional purposes, cannot be guarded.

WARNING: Indicates a potentially hazardous situation that, if not avoided, could result in death or serious injury, and includes hazards that are exposed when guards are removed. It may also be used to alert against unsafe practices.

CAUTION: Indicates a potentially hazardous situation that, if not avoided, may result in minor or moderate injury. It may also be used to alert against unsafe practices.

If you have questions not answered in this manual or require additional copies or the manual is damaged, please contact your dealer or the manufacturer directly.

IMPORTANT SAFETY INFORMATION!















Working with unfamiliar equipment can lead to careless injuries. Read this manual, and the manual for your tractor, before assembly or operating, to acquaint yourself with the machines. It is the implement owner's responsibility, if this machine is used by any person other than yourself, is loaned or rented, to make certain that the operator, prior to operating:

1. Reads and understands the operator's manuals.
2. Is instructed in safe and proper use.















The use of this equipment is subject to certain hazards which cannot be protected against by mechanical means or product design. All operators of this equipment must read and understand this entire manual, paying particular attention to safety and operating instructions, prior to using. If there is something in this manual you do not understand, ask your supervisor, or your dealer, to explain it to you.

SAFETY INSTRUCTIONS (continued)

-  All equipment is potentially hazardous. There is no substitute for a cautious, safe-minded operator who recognizes potential hazards and follows reasonable safety practices.
-  When the use of hand tools is required to perform any part of assembly, installation, adjustment, maintaining, repairing, removal, or moving the implement, be sure the tools used are designed and recommended by the tool manufacturer for that specific task.
-  Personal protection equipment including safety glasses, safety shoes, and gloves are recommended during assembly, installation, operation, adjustment, maintaining, repairing, removal, or moving the implement.
-  Always use two people to handle heavy, unwieldy components during assembly, installation, removal, or moving the implement.
-  Never place any part of your body where it would be in danger if movement should occur during assembly, installation, operation, maintaining, repairing, removal, or moving the implement.
-  Never place yourself between the tractor and implement while implement is in operation.
-  Do not work under a raised implement unless it is securely blocked or held in position. Do not depend on the tractor hydraulic system to hold the implement in place.
-  A heavy load can cause instability of the tractor. Use extreme care during travel. Slow down on turns and watch out for bumps. The tractor may need front counter-weights to counter-balance the weight of the implement.
-  Never use alcoholic beverages or drugs which can hinder alertness or coordination while operating this equipment. Consult your doctor about operating this machine while taking prescription medications.
-  Do not allow others to ride on the tractor with an operator. Riders are subject to injury such as being struck by foreign objects or being thrown off. Riders obstruct the operator's view resulting in unsafe operation. **Never allow anyone to ride on the implement!**
-  Before you operate the implement, check over all pins, bolts and connections to be sure all are securely in place. Replace any damaged or worn parts immediately.
-  Do not allow anyone who is not familiar with the safety rules and operation instructions to use this implement.
-  Never allow children to operate or be around equipment.
-  Use stabilizer bars, adjustable sway chains, or sway blocks on your tractor lift arms to keep the implement from swinging side to side. Adjust as tightly as practical for best performance.

SAFETY INSTRUCTIONS (continued)

-  Keep alert and watch the front as well as the rear when working with the box scraper.
-  When maneuvering close to buildings or passing through narrow areas, be sure to allow sufficient clearance for the box scraper.
-  Do not operate close to ditches or creeks. Slow down when operating over rough ground.
-  Always be sure the box scraper is in the fully raised position when in transport.
-  When removing, changing the shanks, be sure that your feet are never under the box scraper.
-  Use extreme caution when backfilling deep holes or trenches.
-  Be careful to avoid catching the box scraper on stumps or other immovable objects.
-  Use care when working on slopes.
-  Avoid excessive speed during operation.
-  Make adjustments only when the box scraper is attached to the tractor.
-  When using the box scraper in a reverse position, use extra care. **Do not ram box scraper** into piles of dirt. Tractor lift arms and the box scraper are not built to take high impact loads in this position. **Ramming** backwards can also dislodge operator from seat and/or tractor controls, resulting in possible serious injury or death.
-  Always ease the tractor into the load. It may be necessary to reposition and take less “bite” on the material to move it safely.
-  Watch for and avoid hidden obstructions, i.e., buried pipes, rocks, concrete piers, uneven concrete slabs, stumps, etc., when operating.

SAFETY SIGNS

This SAFETY SIGN is located on the frame of your box scraper. Obey ALL Safety Warnings.

**NOTE:
If Safety Sign is missing or damaged, replace immediately.**



CAUTION

Failure to follow safe operating practices can cause property damage and bodily injury.



1. Use tractor hitch sway bars to prevent side sway.
2. Never ram box scraper into dirt piles in reverse position. Ramming backwards can unseat operator from tractors or controls.
3. Use extreme caution when backfilling deep holes or trenches.
4. Keep feet clear when adjusting shanks.
5. Watch for and avoid obstructions. Never hit mounds or ridges at high speed as obstructions may be hidden.
6. Read other safety precautions in owner's manual.

101151

INSTRUCTIONS

TRACTOR REQUIREMENTS AND PREPARATION

The SBX Series Box Scrapers will fit most Category I Tractors equipped with a standard 3-point hitch. The BX-48 box scraper will fit Cat. 0 3-point hitch tractors when equipped with Cat. 0/I pull pins.

If tractor has Cat. 0 (20") lift arm spacing and Cat. I lift arm balls (7/8" dia.), then install the pins to the inside (SBX-4 model only).

Check the tractor's 3-point hydraulic lift system. It should operate up and down smoothly and hold its position when set. Refer to your tractor owner's manual or dealer for any adjustments necessary to put the 3-point hydraulic lift system in good working order. (I&T shop manuals will list most specifications and adjustment instructions - available from most farm equipment dealers.)

Tractor should be equipped with stabilizer bars, adjustable sway chains, or sway blocks to keep the implement from swinging side to side.

Smaller size tractors may need front counter weights to counter-balance the weight of the implement.

It is recommended that the tractor be equipped with a Rollover Protection System (ROPS) and a seat belt that is used.



Be sure your tractor is in good condition. Read all the safety precautions and make sure all tractor operators are familiar with the safety rules of operation.

ASSEMBLY AND MOUNTING

1. Attach the upper 3-point a-frame members, to the lower 3-point hitch lugs as shown on page 5, with hardware as indicated. **DO NOT** tighten hardware. Align the a-frame top link and lower hitch holes in order to allow your hitch pins to pass through them. A-frame should be positioned square to the box scraper frame when tightening hardware.
2. Before inserting shanks, attach box scraper to tractor 3-point hitch using top 3-point hitch pin and lynch pins furnished by customer, or raise up front of box scraper and support with blocks.

SHANK SETTING & ADJUSTMENTS

Remove shanks from shipping position and insert into shank tube from the bottom side with tips pointing towards the tractor. Position shank to the desired depth and secure with shank lock pin (#19) and hair pin cotter (#20).

Shank settings from bottom of end plate to tip of shanks are as follows:



**KEEP FEET CLEAR
WHEN LOWERING SHANKS!**

Top Hole - 5 $\frac{1}{2}$ " Below
Second Hole - 3 $\frac{1}{2}$ " Below
Third Hole - 1 $\frac{1}{2}$ " Below
Fourth Hole - $\frac{1}{2}$ " Above

PITCH ADJUSTMENT

Leveling the box scraper or increasing the pitch of the cutting blade is accomplished by adjusting the top link of the tractor.



When using the box scraper in a reverse position use extra care - DO NOT RAM BOX SCRAPER into dirt piles! Tractor lift arms and the box scraper are not built to take high impact loads in this position. RAMMING backwards can also dislodge operator from seat and/or tractor controls, resulting in possible serious injury or death.

STORAGE

At the end of the working season or when the box scraper will not be used for a long period, it is good practice to clean off any dirt or grease that may have accumulated on the scraper and any of the moving parts.

Inspect the scraper for loose, damaged or worn parts and adjust or replace if needed.

Repaint parts where paint is worn or scratched to prevent rust.

Store box scraper in a clean, dry place.

BOX SCRAPER PARTS LIST

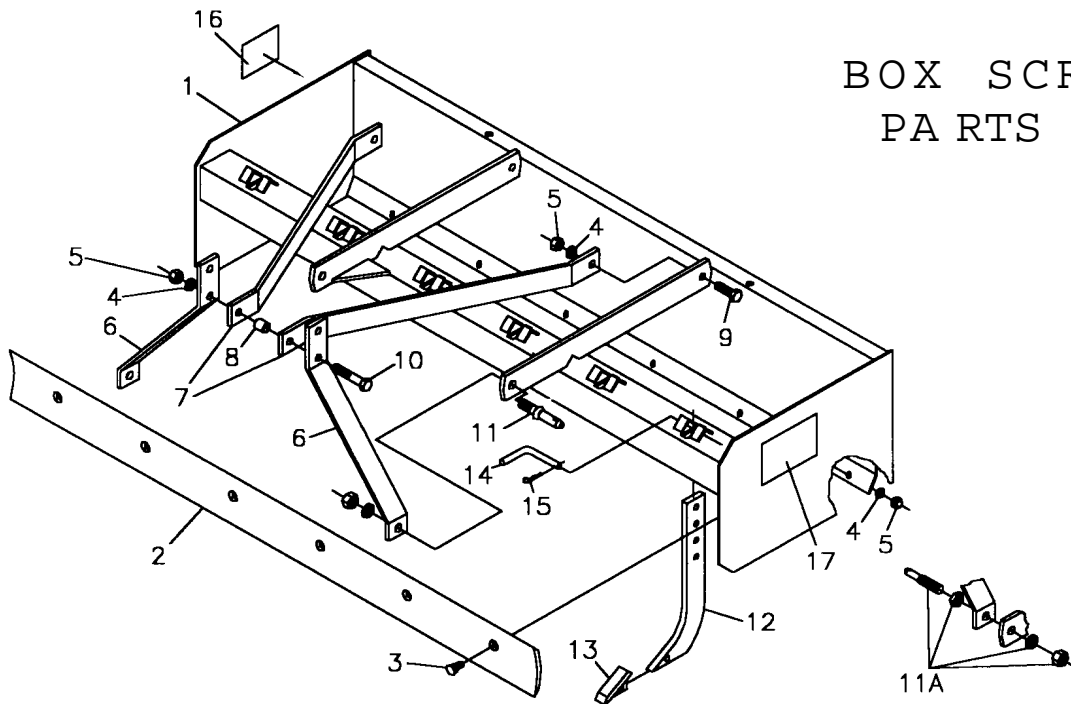

Ref. No.	Part No.	Description	No. Req'd.
1	341321	Main Frame Weldment (SBX-4)	1
	341326	Main Frame Weldment (SBX-5)	1
	341331	Main Frame Weldment (SBX-5.5)	1
	341336	Main Frame Weldment (SBX-6)	1
	341341	Main Frame Weldment (SBX-7)	1
	341346	Main Frame Weldment (SBX-8)	1
2	341322	Cutting Edge (SBX-4)	2
	341327	Cutting Edge (SBX-5)	2
	341332	Cutting Edge (SBX-5.5)	2
	341337	Cutting Edge (SBX-6)	2
	341342	Cutting Edge (SBX-7)	2
	341347	Cutting Edge (SBX-8)	2
3	2503045	Bolt 5/8"-11NC x 1 1/2" Plow Head	Var.
4	2502007	Washer 5/8" Springlock	Var.
5	2500013	Nut 5/8"-11NC Full Hex	Var.
6	341323	Strap, Toplink (SBX-4 only)	2
	341328	Strap, Toplink	2
7	341324	Strap, Tie (SBX-4 only)	2
	341329	Strap, Tie	2
8	341333	Spacer, Toplink	1
9	2503048	Bolt 5/8"-11NC x 2" Hex Head	2
10	2503066	Bolt 5/8"-11NC x 4" Hex Head	1
11	590108	Draw Pin, Cat. I (AK-578)	2
11A	590330	Draw Pin, Cat. 0 (Optional - SBX-4 only)	2
12	341334	Shank, Scarifier w/Tip (Ref. #13)	Var.
13	341338	Replaceable Wear Tip	Var.
14	341339	Pin, Lock	Var.
15	590187	Hair Clip Pin (AK-2704)	Var.
16	101128	Safety Sign - Caution (Avoid Injury)	1
17	101151	Safety Sign - Caution (Safe Practices)	1

SPECIFICATIONS

SBX SERIES FIXED BAR BOX SCRAPERS

MODEL/SERIES	SBX - 4	SBX - 5	SBX - 5½	SBX - 6	SBX - 7	SBX - 8
WORKING WIDTH	48"	60"	66"	72"	84"	96"
HEIGHT OF MOLDBOARD	-----		16.5 inches	-----		
DEPTH OF BUCKET	-----		21.5 inches	-----		
OVERALL LENGTH	-----		26 inches	-----		
TOTAL HEIGHT	-----		34 inches	-----		
WEIGHT (POUNDS)	298	376	418	454	524	592
NUMBER OF SHANKS	3	4	4	5	6	7
MAXIMUM H.P. RATING	25	35	40	40	50	50
LOWER HITCH	Bolted Pin	Bolted Pin	Bolted Pin	Bolted Pin	Clevis	Clevis

