

# OWNER'S MANUAL

**MODEL NO.  
580**

## **! CAUTION**

For Safe Operation  
Read Rules And  
Instructions Carefully

SINO LEEINGLES, PIDA AYUDA  
A AIGUIEN QUE SI LO LEA  
PARA QUE LE TRADUZCA LAS  
MEDIDAS DE SEGURIDAD.

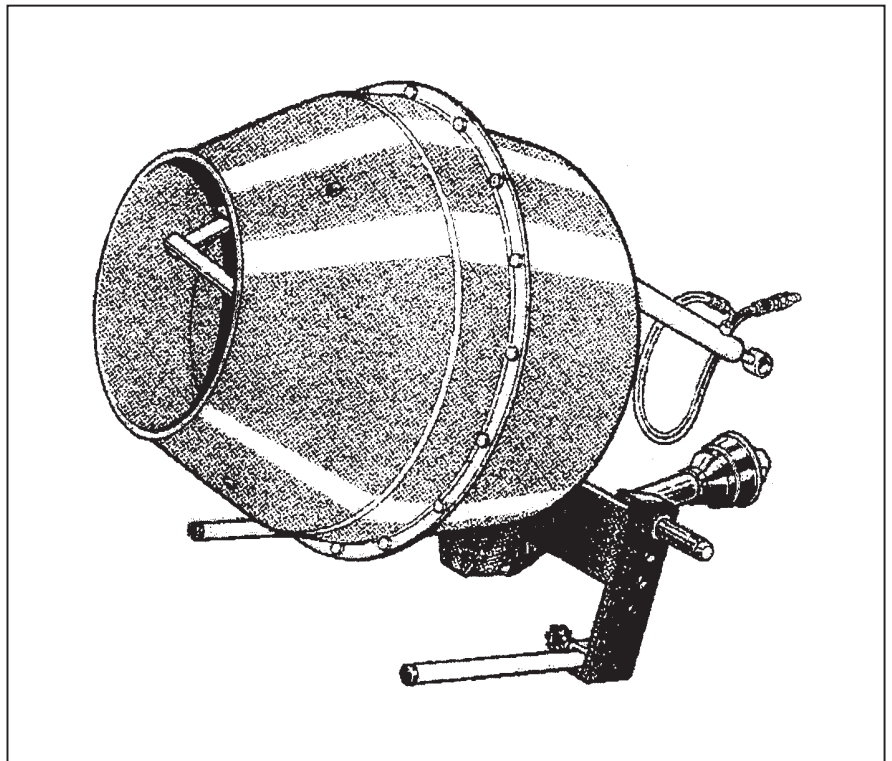

## **3 PT. MIXER**

**Safety Instructions**

**Tractor Preparation**

**Operating Instructions**

**Assembly & Mounting**

**Maintenance**

**Repair Parts**

## **! CAUTION**

**THE FOLLOWING SAFETY PRECAUTIONS SHOULD BE THOROUGHLY UNDERSTOOD  
BEFORE ATTEMPTING TO BEGIN ASSEMBLING THIS MACHINE**

1. Select an area for assembly that is clean and free of any debris which might cause persons working on the assembly to trip.
2. Do not lift heavy parts or assemblies. Use crane, jack, tackle, fork trucks or other mechanical devices.
3. Preview the assembly instructions in your operator's manual before proceeding further.
4. If the assembly instructions call for parts or assemblies to be blocked up, use only blocking material that is in good condition and is capable of handling the weight of the assembly to be blocked. Also insure that the blocking material is on a clean, dry surface.
5. Never put hands, or any part of body, under blocked up assemblies if at all possible.
6. After completing assembly, thoroughly inspect the machine to be sure that all nuts, bolts, hydraulic fittings or any other fastened assemblies have been thoroughly tightened.
7. Before operating the machine, thoroughly read the operation section of your operator's manual.
8. Before operating, read the maintenance section of your operator's manual to be sure that any parts requiring lubrication, such as gearboxes, are full, to avoid any possible damage.
9. **Before operating equipment – If you have any questions regarding the proper assembly or operation, contact your dealer or representative.**

# TABLE OF CONTENTS

WARRANTY .....	2
SAFETY INFORMATION .....	3
SAFETY SIGNS .....	13
PREPARATION INSTRUCTIONS .....	14
OPERATING INSTRUCTIONS .....	18
TROUBLE-SHOOTING .....	20
PARTS LISTS .....	21

SINO LEEINGLES, PIDA AYUDA A AIGUIEN QUE SI LO LEA PARA QUE LE TRADUZCA LAS MEDIDAS DE SEGURIDAD.

## STATEMENT OF POLICY

It is the policy of Worksaver, Inc. to improve its products where it is possible and practical to do so. Worksaver, Inc. reserves the right to make changes or improvements in design and construction at any time, without incurring the obligation to make these changes on previously manufactured units.

## TO THE OWNER :

Read this manual before using your 3 pt. Mixer. This manual is provided to give you the necessary operating and maintenance instructions for keeping your 3 pt. Mixer in top operating condition. Please read this manual thoroughly. Understand what each control is for and how to use it. Observe all safety signs on the machine and noted throughout the manual for safe operation of implement. Keep this manual handy for ready reference.

Like all mechanical products, it will require cleaning and upkeep. Lubricate the Mixer as specified.

Use only genuine Worksaver, Inc. service parts. Substitute parts will void the warranty and may not meet standards required for safe and satisfactory operation. Record the model and serial number of your Mixer here:

Model: \_\_\_\_\_ Serial Number: \_\_\_\_\_

---

---

## RETAIL CUSTOMER'S RESPONSIBILITY

**It is the Retail Customer and/or Operator's responsibility to read the Operator's Manual, to operate, lubricate, maintain, and store the product in accordance with all instructions and safety procedures. Failure of the operator to read the Operator's Manual is a misuse of this equipment.**

**It is the Retail Customer and/or Operator's responsibility to inspect the product and to have any part(s) repaired or replaced when continued operation would cause damage or excessive wear to other parts or cause a safety hazard.**

**It is the Retail Customer's responsibility to deliver the product to the authorized Worksaver Dealer, from whom he purchased it, for service or replacement of defective parts which are covered by warranty. Repairs to be submitted for warranty consideration must be made within forty-five (45) days of failure.**

**It is the Retail Customer's responsibility for any cost incurred by the Dealer for traveling to or hauling of the product for the purpose of performing a warranty obligation or inspection.**

# LIMITED WARRANTY



Worksaver warrants to the original purchaser of any new 3 pt. Mixer Model 580, that the equipment be free from defects in material and workmanship for a period of six (6) months for non-commercial, state, and municipalities. Use sixty (60) days for commercial use from date of retail sale.

Replacement or repair parts installed in the equipment covered by this warranty are warranted for ninety (90) days from the date of purchase of such part or to the expiration of the applicable new equipment warranty period, whichever occurs later.

Such parts shall be provided at no cost to the user during regular working hours. Worksaver reserves the right to inspect any equipment or parts which are claimed to have been defective in material or workmanship.

## **DISCLAIMER OF IMPLIED WARRANTIES & CONSEQUENTIAL DAMAGES**

Worksaver's obligation under this warranty, to the extent allowed by law, is in lieu of all warranties, implied or expressed, including implied warranties of merchantability and fitness for a particular purpose and any liability for incidental and consequential damages with respect to the sale or use of the items warranted. Such incidental and consequential damages shall include but not be limited to: transportation charges other than normal freight charges; cost of installation other than cost approved by Worksaver; duty; taxes; charges for normal service or adjustments; loss of crops or any other loss of income; rental of substitute equipment, expenses due to loss, damage, detention or delay in the delivery of equipment or parts resulting from acts beyond the control of Worksaver.

## **THIS WARRANTY SHALL NOT APPLY:**

1. To vendor items which carry their own warranties, such as hydraulic cylinders, tires, and tubes.
2. If the unit has been subjected to misapplication, abuse, misuse, negligence, fire or other accident.
3. If parts not made or supplied by Worksaver have been used in connection with the unit, if, in sole judgement of Worksaver such use affects its performance, stability, or reliability.
4. If the unit has been altered or repaired outside of an authorized Worksaver dealership in a manner which, in the sole judgement of Worksaver affects its performance, stability or reliability.
5. To normal maintenance service and normal replacement items such as gearbox lubricant, hydraulic fluid, worn blades, or to normal deterioration of such things as belts and exterior finish, due to use or exposure.
6. To expendable or wear items such as teeth, chains, sprockets, belts, springs and other items that in the company's sole judgement is a wear item.

NO EMPLOYEE OR REPRESENTATIVE OF WORKSAVER IS AUTHORIZED TO CHANGE THIS WARRANTY IN ANY WAY OR GRANT ANY OTHER WARRANTY UNLESS SUCH CHANGE IS MADE IN WRITING AND SIGNED BY WORKSAVER'S SERVICE MANAGER, POST OFFICE BOX 100, LITCHFIELD, ILLINOIS 62056-0100.



# To the Owner/Operator/Dealer

All implements with moving parts are potentially hazardous. There is no substitute for a cautious, safe-minded operator who recognizes the potential hazards and follows reasonable safety practices. The manufacturer has designed this implement to be used with all its safety equipment properly attached to minimize the chance of accidents.

## BEFORE YOU START!!

**Read the safety messages on the implement and shown in your manual.  
Observe the rules of safety and common sense!**



### THIS SYMBOL MEANS

- ATTENTION!
- BECOME ALERT!
- YOUR SAFETY IS INVOLVED!

THIS SAFETY ALERT SYMBOL IDENTIFIES IMPORTANT SAFETY WARNING MESSAGES. CAREFULLY READ EACH WARNING MESSAGE THAT FOLLOWS. FAILURE TO UNDERSTAND AND OBEY A SAFETY WARNING, OR RECOGNIZE A SAFETY HAZARD, COULD RESULT IN AN INJURY OR DEATH TO YOU OR OTHERS AROUND YOU. THE OPERATOR IS ULTIMATELY RESPONSIBLE FOR THE SAFETY OF HIMSELF, AS WELL AS OTHERS, IN THE OPERATING AREA OF THE TRACTOR AND ATTACHED EQUIPMENT.

---

## UNDERSTAND SIGNAL WORDS

Note the use of the signal words **DANGER**, **WARNING** and **CAUTION** with the safety messages. The appropriate signal word for each has been selected using the following guidelines:

**DANGER:** Indicates an imminently hazardous situation that, if not avoided, will result in death or serious injury. This signal word is to be limited to the most extreme situations typically for machine components which, for functional purposes, cannot be guarded.

**WARNING:** Indicates a potentially hazardous situation that, if not avoided, could result in death or serious injury, and includes hazards that are exposed when guards are removed. It may also be used to alert against unsafe practices.

**CAUTION:** Indicates a potentially hazardous situation that, if not avoided, may result in minor or moderate injury. It may also be used to alert against unsafe practices.

If you have questions not answered in this manual or require additional copies or the manual is damaged, please contact your dealer or the manufacturer directly.

---

## IMPORTANT SAFETY INFORMATION!

Working with unfamiliar equipment can lead to careless injuries. Read this manual, and the manual for your tractor, before assembly or operating, to acquaint yourself with the machines. It is the implement owner's responsibility, if this machine is used by any person other than yourself, is loaned or rented, to make certain that the operator, prior to operating:

1. Reads and understands the operator's manuals.
2. Is instructed in safe and proper use.



The use of this equipment is subject to certain hazards which cannot be protected against by mechanical means or product design. All operators of this equipment must read and understand this entire manual, paying particular attention to safety and operating instructions, prior to using. If there is something in this manual you do not understand, ask your supervisor, or your dealer, to explain it to you.

## SAFETY INSTRUCTIONS (continued)



### EQUIPMENT SAFETY GUIDELINES



Safety of the operator is one of the main concerns in designing and developing a new piece of equipment. Designers and manufacturers build in as many safety features as possible. However, every year many accidents occur which could have been avoided by a few seconds of thought and a more careful approach to handling equipment. You, the operator, can avoid many accidents by observing the following precautions in this section. To avoid personal injury, study the following precautions and insist those working with you, or for you, follow them.



In order to provide a better view, certain photographs or illustrations in this manual may show an assembly with a safety shield removed. However, equipment should never be operated in this condition. Keep all shields in place. If shield removal becomes necessary for repairs, replace the shield prior to use.



Replace any CAUTION, WARNING, DANGER or instruction safety sign that is not readable or is missing. Location of such safety signs is indicated in this booklet.



Never use alcoholic beverages or drugs which can hinder alertness or coordination while operating this equipment. Consult your doctor about operating this machine while taking prescription medications.



Review the safety instructions with all users annually.



This equipment is dangerous to children and persons unfamiliar with its operation. The operator should be a responsible adult familiar with farm machinery and trained in this equipment's operations. **Do not allow persons to operate or assemble this unit until they have read this manual and have developed a thorough understanding of the safety precautions and of how it works.**



To prevent injury or death, use a tractor equipped with a Roll-Over Protective System (ROPS). Do not paint over, remove or deface any safety signs or warning signs on your equipment. Observe all safety signs and practice the instruction on them.



Never exceed the limits of a piece of machinery. If its ability to do a job, or to do so safely, is in question - **DON'T TRY IT.**



Do not modify the equipment in any way. Unauthorized modification may impair the function and/or safety and could affect the life of the equipment.







In addition to the design and configuration of this implement, including Safety Signs and Safety Equipment, hazard control and accident prevention are dependent upon the awareness, concern, prudence, and proper training of personnel involved in the operation, transport, maintenance, and storage of the machine. Refer also to Safety Messages and Operation Instructions in each of the appropriate sections of the Tractor and Implement Manuals. Pay close attention to the Safety Signs affixed to the Tractor and the Implement.







## SAFETY INSTRUCTIONS (continued)



### **SAFETY SIGNS**





-  Keep safety signs clean and legible at all times.
-  Replace safety signs that are missing or have become illegible.
-  Replaced parts that displayed a safety sign should also display the current sign.
-  Safety signs are available from your Distributor or Dealer Parts Department or the factory.

### **How to Install Safety Signs:**

-  Be sure that the installation area is clean and dry.
-  Be sure temperature is above 50°F (10°C).
-  Decide on the exact position before you remove the backing paper.
-  Remove the smallest portion of the split backing paper.
-  Align the sign over the specified area and carefully press the small portion with the exposed sticky backing in place.
-  Slowly peel back the remaining paper and carefully smooth the remaining portion of the sign in place.
-  Small air pockets can be pierced with a pin and smoothed out using the piece of sign backing paper.



### **TIRE SAFETY**

-  Failure to follow proper procedures when mounting a tire on a wheel or rim can produce an explosion which may result in serious injury or death.
-  Do not attempt to mount a tire unless you have the proper equipment and experience to do the job.
-  Inflating or servicing tires can be dangerous. Whenever possible, trained personnel should be called to service and/or mount tires.
-  Always order and install tires and wheels with appropriate capacity to meet or exceed the anticipated weight to be placed on the equipment.

# SAFETY INSTRUCTIONS (continued)



## **SAFETY TRAINING**



Safety is a primary concern in the design and manufacture of our products. Unfortunately, our efforts to provide safe equipment can be wiped out by a single careless act of an operator.



In addition to the design and configuration of equipment, hazard control and accident prevention are dependent upon the awareness, concern, prudence and proper training of personnel involved in the operation, transport, maintenance and storage of equipment.



It has been said, "The best safety device is an informed, careful operator." We ask you to be that kind of an operator. It is the operator's responsibility to read and understand ALL Safety and Operating instructions in the manual and to follow these. Accidents can be avoided.



Working with unfamiliar equipment can lead to careless injuries. Read this manual, and the manual for your tractor, before assembly or operating, to acquaint yourself with the machines. It is the 3 pt. mixer owner's responsibility, if this machine is used by any person other than yourself, is loaned or rented, to make certain that the operator, prior to operating:

1. Reads and understands the operator's manuals.
2. Is instructed in safe and proper use.



Know your controls and how to stop tractor, engine, and mixer quickly in an emergency. Read this manual and the one provided with your tractor.



Train all new personnel and review instructions frequently with existing workers. A person who has not read and understood all operating and safety instructions is not qualified to operate the machine. An untrained operator exposes himself and bystanders to possible serious injury or death.











Do not allow children to operate this machine.

## SAFETY INSTRUCTIONS (continued)



### PREPARATION

-  Never operate the tractor and implement until you have read and completely understand this manual, the Tractor Operator's Manual, and each of the Safety Messages found on the safety signs on the tractor and implement.
  
-  Personal protection equipment including hard hat, safety glasses, safety shoes, and gloves are recommended during assembly, installation, operation, adjustment, maintaining, repairing, removal, or moving the implement. Do not allow long hair, loose fitting clothing or jewelry to be around moving parts.
  
-  **PROLONGED EXPOSURE TO LOUD NOISE MAY CAUSE PERMANENT HEARING LOSS!**  
Tractors with or without Implement attached can often be noisy enough to cause permanent, partial hearing loss. We recommend that you wear hearing protection on a full-time basis if the noise in the Operator's position exceeds 80db. Noise over 85db on a long-term basis can cause severe hearing loss. Noise over 90db adjacent to the Operator over a long-term basis may cause permanent, total hearing loss. **NOTE:** Hearing loss from loud noise (from tractors, chain saws, radios, and other such sources close to the ear) is cumulative over a lifetime without hope of natural recovery.
  
-  Operate the implement only with a tractor equipped with an approved Roll-Over Protective System (ROPS). Always wear your seat belt on tractors equipped with a ROPS. Serious injury or even death could result from falling off the tractor ---particularly during a turnover when the operator could be pinned under the ROPS or the tractor.
  
-  Operate only in daylight or good artificial light.
  
-  Ensure implement is properly mounted, adjusted and in good operating condition.
  
-  Make sure driveline spring-activated locking pin or balls operate freely and are seated firmly in tractor PTO stub shaft groove.
  
-  Ensure that all safety shielding and safety signs are properly installed and in good condition.
  
-  Check that the PTO driveline does not contact the swinging drawbar of the tractor. The swinging drawbar may have to be removed on some tractors. Damage to the driveline could make it unsafe to operate.



## SAFETY INSTRUCTIONS (continued)



### **STARTING AND STOPPING SAFETY**



Be certain the tractor is in neutral or park position before starting engine.



Do not leave the tractor or the implement unattended with the engine running.



3 Pt. Mixer operating power is supplied from tractor PTO. Refer to your tractor manual for PTO engagement and disengagement instructions. Always operate the PTO in the 540 rpm range. Know how to stop tractor and mixer quickly in case of an emergency.



Mixer should be lifted off the ground before engaging PTO and be sure that no one is near the machine. When engaging PTO, the RPM should always be low.



Never engage PTO drive with the mixer in the dump position. Engaging PTO with mixer in dump position can cause damage to the PTO driveline. This damage could cause the driveline to come apart causing possible injury or death.



When raising mixer with the 3 point hitch, check that the PTO driveline does not go into sharp angles (more than 15°).



Always stop the tractor, set brake, shut off the tractor engine, remove the ignition key, and lower implement to the ground before dismounting tractor. Never leave equipment unattended with the tractor running.



Check the tractor master shield over the PTO stub shaft. Make sure it is in good condition and fastened securely to the tractor. Purchase a new shield if old shield is damaged or missing. (You may have to use a tractor salvage yard for replacement parts on older tractors.)



Take all possible precautions when leaving unit unattended: Disengage PTO, set parking brake, stop engine and remove key from ignition. Park in level area.



### **OPERATIONAL SAFETY**



The use of this equipment is subject to certain hazards which cannot be protected against by mechanical means or product design. All operators of this equipment must read and understand this entire manual, paying particular attention to safety and operating instructions, prior to using. If there is something in this manual you do not understand, ask your supervisor, or your dealer, to explain it to you.



Most accidents occur because of neglect or carelessness. Keep all helpers and bystanders at least twenty (20) feet from an operating mixer. Only properly trained people should operate this machine.



Never place hands or body on mixer with tractor engine running or before you are sure all motion has stopped. Stay clear of all moving parts.















Do not reach or place yourself under equipment until it is blocked securely.

## SAFETY INSTRUCTIONS (continued)

















### **OPERATIONAL SAFETY (continued)**

-  Do not allow riders on the implement or tractor at any time. There is no safe place for any riders.
-  Disengage power takeoff (PTO) and place transmission into neutral before attempting to start engine.
-  Install and secure all guards and shields before starting or operating.
-  Keep hands, feet, hair, and clothing away from moving parts.
-  This mixer is designed for use only on tractors with 540 RPM power takeoff.
-  A full mixer will put a heavy load on the rear of your tractor. Be sure front of tractor is properly counterbalanced with weights.
-  Never place hands or hand held tools (shovel) into the mixer drum while it is turning. It could catch on the mixer paddles and whip around, possibly injuring the operator.
-  Use extreme care and maintain minimum ground speed when transporting on hillside, over rough ground and when operating close to ditches or fences. Be careful when turning sharp corners.
-  Avoid sudden starts and stops while traveling up or downhill.
-  Always drive down slopes; never across the face. Avoid operation on steep slopes. Slow down on sharp turns and slopes to prevent tipping and/or loss of control. Avoid slopes when surface is wet, slippery grass or soil.
-  Never attempt to check or adjust chain tension while implement is operating. Always stop it before this operation.
-  Inspect the entire machine periodically as indicated in the Maintenance Section of this manual. Look for loose fasteners, worn or broken parts, and worn PTO driveline joints and/or shields. Make sure all pins have cotter pins and washers. Serious injury may occur from not maintaining this machine in good working order.

## SAFETY INSTRUCTIONS (continued)













### TRANSPORT SAFETY

-  Comply with state and local laws governing highway safety and movement of farm machinery on public roads.
-  The use of flashing amber lights is acceptable in most localities. However, some localities prohibit their use. Local laws should be checked for all highway lighting and marking requirements.
-  When driving the tractor and equipment on the road or highway under 20 mph (32 kph) at night or during the day, use flashing amber warning lights and a slow moving vehicle (SMV) identification emblem.
-  Always be sure the implement is in the proper raised position for transport.
-  Reduce speed when transporting mounted implements to avoid bouncing and momentary loss of steering control.
-  Plan your route to avoid heavy traffic.
-  Always install transport locks, pins or brackets before transporting.
-  Do not drink and drive!
-  Watch for traffic when operating near or crossing roadways.
-  Turn curves or go up or down hills only at a low speed and at a gradual steering angle. Make certain that at least 20% of the tractor's weight is on the front wheels to maintain safe steering. Slow down on rough or uneven surfaces, and loose gravel.
-  Use extreme care and maintain minimum ground speed when transporting on hillside, over rough ground and when operating close to ditches or fences. Be careful when turning sharp corners.
-  Never allow riders on either tractor or implement. Falling off can kill.
-  Be a safe and courteous driver. Always yield to oncoming traffic in all situations, including narrow bridges, intersections, etc.
-  Do not exceed 20 mph (32 kph). Reduce speed on rough roads and surfaces.
-  Always disengage PTO before driving the tractor to transport the implement from one place to another.

## SAFETY INSTRUCTIONS (continued)







### MAINTENANCE SAFETY

-  Good maintenance is your responsibility. Poor maintenance is an invitation to trouble.
  
-  Follow good shop practices.
  - Keep service area clean and dry.
  - Be sure electrical outlets and tools are properly grounded.
  - Use adequate light for the job at hand.
  
-  Make sure there is plenty of ventilation. Never operate the engine of the towing vehicle in a closed building. The exhaust fumes may cause asphyxiation.
  
-  Before working on this machine, drive to a level area, disengage the PTO, lower implement (or if working underneath, raise and block securely), shut off the engine, set the brakes, and remove the ignition keys.
  
-  Be certain all moving parts on attachments have come to a complete stop before attempting to perform maintenance.
  
-  Never work under equipment unless it is blocked securely. Never depend on hydraulic system to keep implement in raised position.
  
-  Keep all persons away from operator control area while performing adjustments, service, or maintenance.
  
-  Always use personal protection devices such as eye, hand and hearing protectors, when performing any service or maintenance.
  
-  Periodically tighten all bolts, nuts and screws and check that all cotter pins are properly installed to ensure unit is in a safe condition.
  
-  When completing a maintenance or service function, make sure all safety shields and devices are installed before placing unit in service.
  
-  Openings in the skin and minor cuts are susceptible to infection from hydraulic fluid. If injured by escaping hydraulic fluid, see a doctor at once. Gangrene and death can result. Without immediate medical treatment, serious infection and reactions can occur.

## SAFETY INSTRUCTIONS (continued)









### **MAINTENANCE SAFETY (continued)**

-  After servicing, be sure all tools, parts and service equipment are removed.
-  Check to ensure all safety signs are installed and in good condition. (See safety sign section for location drawing.)
-  Never replace hex bolts with less than grade five bolts unless otherwise specified, i.e. shear bolts. Refer to bolt torque chart for head identification marking.
-  Where replacement parts are necessary for periodic maintenance and servicing, genuine factory replacement parts must be used to restore your equipment to original specifications. The manufacturer will not claim responsibility for use of unapproved parts and/or accessories and other damages as a result of their use.
-  If equipment has been altered in any way from original design, the manufacturer does not accept any liability for injury or warranty.
-  A fire extinguisher and first aid kit should be kept readily accessible while performing maintenance on this equipment.



### **STORAGE SAFETY**

-  Following operation, or when unhooking, stop the tractor, set the brakes, disengage the PTO, shut off the engine and remove the ignition keys.
-  Store the unit in an area away from human activity.
-  Do not park equipment where it will be exposed to livestock for long periods of time. Damage and livestock injury could result.
-  Do not permit children to play on or around the stored unit.
-  Make sure all parked machines are on a hard, level surface and engage all safety devices.
-  If blocking is used, make sure it is solid and secure before leaving area.

# SAFETY SIGNS

72.0291.00

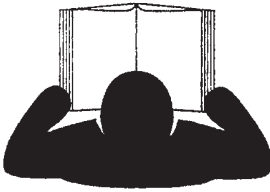

**! WARNING**

To prevent Serious Injury or Death

- Avoid unsafe operation or maintenance.
- Do not operate or work on this machine without reading and understanding the operator's manual.
- If manual is lost, contact your nearest dealer for a new manual.

101170 (GB)

**! DANGER**



**ROTATING DRIVELINE CONTACT CAN CAUSE DEATH  
KEEP AWAY!**

Do not operate without -

- All driveline, tractor and equipment shields in place.
- Drivelines securely attached at both ends.
- Driveline shields that turn freely on driveline.

101103 SW101

**! WARNING**



**HIGH-PRESSURE FLUID HAZARD**

To prevent serious injury or death:

- Relieve pressure on system before repairing or adjusting or disconnecting.
- Wear proper hand and eye protection when searching for leaks. Use wood or cardboard instead of hands.
- Keep all components in good repair.

SW700

**! WARNING**

**540 RPM SPEED RANGE ONLY**

**HIGHER PTO SPEEDS CAN CAUSE PERSONAL INJURY AND EQUIPMENT FAILURE**

101101

**! CAUTION**

**TURN PTO OFF**

Before Dumping Mixer  
Never Exceed 25° Angle At  
The PTO Shaft U-Joint

PART NO. 101029

**! WARNING**

**Stand clear**

101027

REMEMBER: If Safety Signs have been damaged, removed, become illegible or parts replaced without Signs, new Safety Signs must be applied. New Safety Signs are available from your authorized distributor or factory.

# INSTRUCTIONS

## TRACTOR REQUIREMENTS AND PREPARATION

The model 580 mixer requires a tractor with a Category I hitch and to be of sufficient size to handle a loaded mixer drum. Five cubic feet of concrete weighs 685 lbs. and the 580 mixer weighs 215 lbs. for a total weight of 900 lbs. Always be sure your tractor is properly counter-balanced for a safe operation.

A smaller size tractor (20-25 hp) equipped with front end weights or equipped with a front end loader can usually handle the mixer easily.

**NOTE:** Small low-profile tractors will generally not work with the 580 mixer as they are so low they cannot dump the mixer into forms of any height.

The tractor must have one hydraulic power remote to power the dump cylinder.

The tractor must be equipped with a 540 rpm PTO (power takeoff) in good working condition.

It is recommended that only tractors with wide front axles be used with the mixer. Tricycle front wheel arrangements are inherently unstable and tractor roll-over accidents are more likely to occur.

The tractor also needs lift arm stabilizer bars or sway blocks to control side movement of the mixer.

Check the tractor's 3-pt. hydraulic lift system. Refer to your tractor operator's manual or dealer for any adjustments necessary to put the hydraulic system in good working order. (I&T shop manuals will list most specifications and adjustment instructions - available from most farm equipment dealers.)

Be sure tires and rims are in good condition. Inflate tires to the proper recommended air pressure.

Check the tractor master shield over the PTO stub shaft. Make sure it is in good condition and fastened securely to the tractor. Purchase a new shield if old shield is damaged or missing. (You may have to use a tractor salvage yard for replacement parts on older tractors.)

It is recommended that a ROPS (Roll-Over Protection Structure) and a seat belt be installed on all tractors. Contact your local dealer for a ROPS for your tractor.

The operator is responsible for the safe operation of this mixer. The operator must be properly trained. Operators should be familiar with the mixer and tractor and all safety practices before starting operation. Read the safety rules and safety signs on pages 3-13.



**A heavy load can cause instability in driving a tractor. Make sure the front of the tractor is properly counter-balanced with weights. Always drive slowly - especially around turns. An unstable tractor could steer badly and possibly tip over, causing injury or death.**

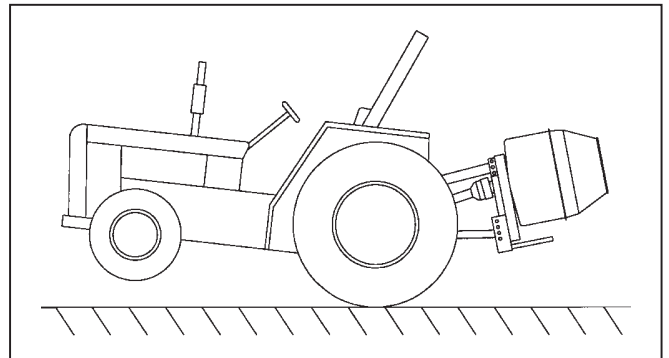

**Figure 1. Tractor Stability**



**When using 3 pt. hitch equipment, a minimum 20% of tractor and equipment weight must be on tractor front wheels. Without this weight, tractor could tip up, causing possible loss of control and possible personal injury or death. The weight may be attained with a front end loader, front wheel weights, ballast in tires or front tractor weights. When attaining a minimum 20% of tractor and equipment weight on the front wheels, you must not exceed the ROPS weight certification. Weigh the tractor and equipment. DO NOT GUESS OR ESTIMATE!**



**Be sure your tractor is in good condition. Read all the safety precautions and make sure all tractor operators are familiar with the safety rules of operation.**



**SAFETY . . .  
YOU CAN LIVE WITH IT!**

# INSTRUCTIONS (continued)

## ASSEMBLY

This unit is shipped almost completely assembled. Carefully follow instructions for final assembly.

Before attempting assembly check the following items. Having all the needed parts and equipment readily at hand will speed up your assembly task and will make the job as safe as possible.

- Check for fasteners and pins that were shipped with the mixer. All hardware coming from the factory has been installed in the location where it will be used. If a part or fastener is temporarily removed for assembly reasons, remember where it goes. Keep the parts separated.
- Have a minimum of 2 people at hand during assembly.

Refer to the Safety Precautions and Warnings on the front cover and in the Safety Section of this manual prior to working on the machine.

The pull pins must be installed on the outside of the mixer frame.

Attach the mixer to the lower lift arms of the tractor. Use two (2)  $\frac{7}{16}$ " lynch pins (not furnished) to lock the pull pins to the lift arms. **NOTE! Be sure to always use stabilizer bars to prevent side sway on the mixer.** Failure to use stabilizer bars on the 3 pt. hitch could cause breakage of the hydraulic toplink cylinder or the PTO driveline.

Install the special, toplink hydraulic cylinder to the tractor, using the pin furnished with the tractor. The hydraulic cylinder is a single acting cylinder.

Attach the hose to the rod end of the toplink cylinder. Use a good quality thread sealant. **DO NOT USE TEFLON TAPE.** The port of the hydraulic toplink cylinder are  $\frac{1}{4}$ " pipe thread.

The tractor end of the hose will connect to a  $\frac{1}{2}$ " - 14 NPT standard hydraulic quick coupler tip.

**NOTE:** The rod end of the hydraulic cylinder connects to the tractor toplink brackets and the cylinder body connects to the adjustable links as shown in the parts view.

**NOTE:** The hydraulic toplink cylinder is single acting, it may require adjustment on your tractor valve to operate (check tractor owner's manual).

Use caution when trial dumping the mixer. Allowing the mixer to dump too far may bind the rod end of the hydraulic cylinder and bend the rod.

If it appears this will happen, move the hydraulic cylinder to a higher hole position and/or move the lower lift pins to a lower hole position. It is suggested that you start with the center hole positions and work from there.

## PTO INSTALLATION

In some cases it will be necessary to shorten the PTO assembly to match your particular tractor. The following procedure should be used:

- Check that the driveline is the correct length Figure 2.

The minimum coupling length (overlap) must be no less than 180 mm (6 inches) in each work position.

Driveline travel must still be about 25 mm (1 inch) in the maximum coupling (overlap) position. See Figure 2.

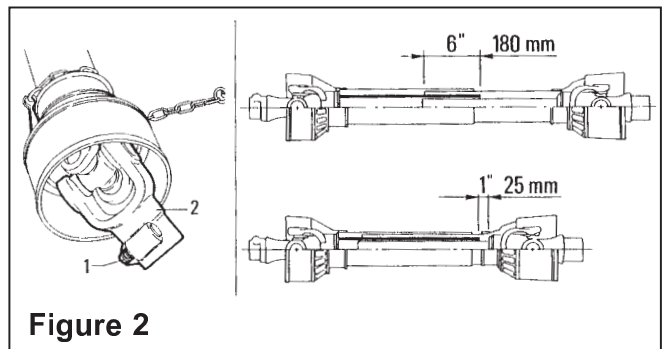

Figure 2

Always couple the two end yokes of the driveline and check that they are locked in place.

To achieve this condition, completely insert the latch pin (Ref. #1, Figure 2) into the groove in the PTO shaft on the tractor. Install the bolt through the yoke and input shaft on the mixer.

An unlocked shaft would slip out of position, causing notable mechanical damage and serious injury to anyone near.

If the driveline is too long, it should be shortened in the following way:

- Set the machine PTO input shaft at a minimum distance from the tractor PTO stub shaft; then set the tractor brakes and switch the engine off.
- Separate the two halves of the driveline. Install the female part into the tractor PTO and the male part on the machine PTO, checking that the position is correct by means of the latch pin.

**OBEY ALL SAFETY WARNINGS!**



# INSTRUCTIONS (continued)

## ASSEMBLY (continued)

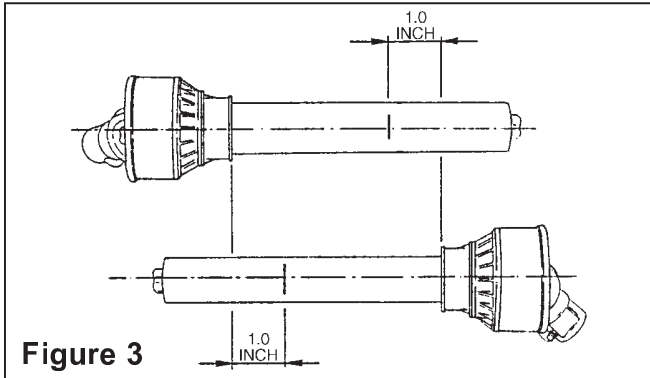

1. Place the two halves of the driveline together, keeping them parallel (see Figure 3). Using a felt-tip pen, matchmark the place where the two halves must be shortened, measuring 1.0 inch from the beginning of each half, as shown in Figure 3.

**Double check before making any cuts. Cut PTO drivelines cannot be returned.**

2. Raise and lower the mixer to determine position with greatest distance between the PTO shaft and mixer input shaft. Shut tractor off, leaving mixer in position of greatest distance between shafts. **SECURELY BLOCK MIXER IN POSITION.**
3. Hold driveline sections parallel to each other and check for **minimum 6" (15cm) overlap**. If driveline has been marked for cutting, overlap will be the distance between the two marks. If driveline has less than minimum overlap, **do not use**. Contact authorized dealer.

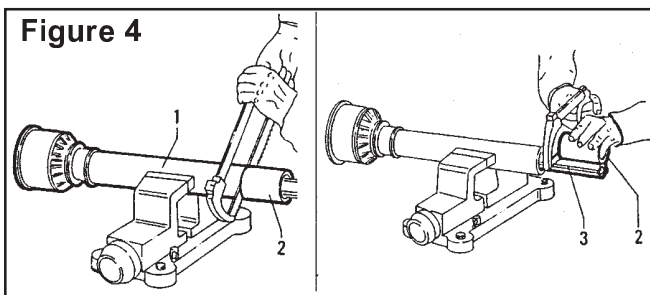

4. If driveline must be cut to a shorter length, clamp driveline in a well padded vise to prevent damage to the shield. Cut off shield where marked. Using cut-off section of shield as a guide, cut shaft the same amount. (Figure 4.)

5. Repeat the procedure to the other driveline half. Remove all burrs and cuttings.

6. Apply multi-purpose grease to inside of outer (female) driveline section. Assemble driveline and install on tractor and mixer. Pull on each driveline section to be sure yokes lock into place. Make certain driveline shielding is in place and in good condition.



**When attaching PTO yoke to tractor PTO shaft, it is important that spring-activated locking pin or balls operate freely and are seated in groove on PTO shaft. A loose shaft could slip off and result in personal injury or damage to equipment.**

7. Carefully raise and lower the mixer and check to be sure the PTO assembly does not jam. If it does, cut equal amounts from each half of the PTO assembly.
8. Check the swinging drawbar of the tractor and make sure the PTO driveline assembly will not contact. The swinging drawbar can be moved forward on some tractors or it can be removed.

If the PTO driveline assembly contacts the swinging drawbar, damage will occur to the driveshaft shield and possibly the driveshaft itself. (NOT covered under warranty.)

**NOTE:** This type of damage is **NOT** covered under warranty, as it is totally under the control and the responsibility of the operator.



**READ MANUAL BEFORE OPERATING!**

## INSTRUCTIONS (continued)

### SAFETY TRAINING

- Know your controls and how to stop tractor, engine, and PTO quickly in an emergency. **READ THIS MANUAL AND THE ONE PROVIDED WITH YOUR TRACTOR.**
- To avoid accident or injury, do not allow anyone to operate this equipment without proper instructions. Any person who operates this equipment must be instructed in and be capable of the safe operation of the tractor, implement and all controls.
- Do not allow children to operate this machine.



A heavy load can cause instability in driving a tractor. Make sure the front of the tractor is properly counterbalanced with weights. Always drive slowly – especially around turns. An unstable tractor could steer badly and possibly tip over, causing injury or death.



Do not operate the PTO at other than the rated 540 RPM. Excessive speeds can cause breakage and potential injury.

**NOTE:** NEVER LOAD MIXER WITH THE DRUM NOT TURNING. STARTING A LOADED DRUM COULD DAMAGE THE DRIVE CHAIN OR SPROCKETS.

- U **Equip tractors with roll-over protection (ROPS) and keep all machinery guards in place.**
- U **Keep children away from danger all day, every day . . .**
- U **Please work, drive, play and live each day with care and concern for your safety and that of your family and fellow citizens.**

**REPLACE  
SAFETY SIGNS  
IF DAMAGED  
OR MISSING!**

---

**OBHEY ALL  
SAFETY WARNINGS!**

---

# OPERATING INSTRUCTIONS

## PRE-OPERATION CHECKLIST

### (OWNER/OPERATOR RESPONSIBILITY)

- \_\_\_ Review and follow safety rules and safety signs on pages 3 through 13.
- \_\_\_ Check that mixer is properly and securely attached to tractor.
- \_\_\_ Make sure driveline spring-activated locking pin or locking balls operate freely and are seated firmly in tractor PTO spline groove.
- \_\_\_ Lubricate all grease fitting locations. Make sure PTO shaft slip joint is lubricated.
- \_\_\_ Check that all hardware is properly installed.
- \_\_\_ Check that all shields and guards are properly installed and in good condition.
- \_\_\_ Place tractor PTO and transmission in neutral before starting engine.
- \_\_\_ Set tractor PTO gear select lever for 540 rpm operation.
- \_\_\_ Check that no one enters the area of machine operation. Always work at a safe distance from people, pets, and livestock.
- \_\_\_ Know your controls and how to stop tractor, engine and PTO quickly in an emergency. **READ THIS MANUAL AND THE ONE PROVIDED WITH YOUR TRACTOR.**
- \_\_\_ To avoid accident or injury, do not allow anyone to operate this equipment without proper instructions. Any person who operates this equipment must be instructed in and be capable of the safe operation of the tractor, implement and all controls.
- \_\_\_ Check that PTO driveline shields are securely locked and clear the swinging drawbar.

Safety is a primary concern in the design and manufacture of our products. Unfortunately, our efforts to provide safe equipment can be wiped out by a single careless act of an operator.

It has been said, "The best safety device is an informed, careful operator". We ask you to be that kind of an operator.

## OPERATION

For best mixing, the drum should be inclined upward 10° to 15° (see Fig. 5). Add some water before cement, sand or aggregate is put in drum.

**NOTE: ONLY LOAD MIXER WHILE DRUM IS TURNING.**

The amount of water used per sack of cement is the key to quality concrete. Use 5, 6 or 7 gallons of water per sack of cement with dry sand and dry aggregate depending on the strength of concrete required. The less water you use the stronger the concrete will be and we suggest that you deduct approximately 1 gallon if the material is wet and approximately 1½ gallons if very wet.

We suggest mixing a trial batch to determine exact proportions you will want to use. If too wet, add more sand and aggregate. If too stiff, reduce the amount of sand and aggregate in the next batch, but **never** add more water to a batch once you have established the correct proportions to use.

After concrete is poured, it is screeded or struck off with a straight edge like a 2 x 4 and should then be floated to smooth it. Further troweling or finishing should be delayed until the water sheen has disappeared from the surface. The concrete should be cured at least five days. To prevent evaporation of mixing water, cover with burlap or straw and keep damp or cover with a vapor sealing material to seal in the water and prevent evaporation.

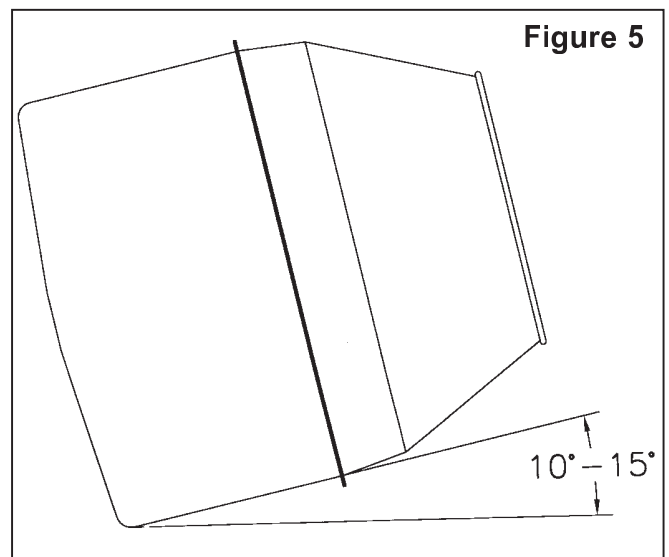

Figure 5



**Never place hands or hand held tools (shovel) into the mixer drum while it is turning. It could catch on the mixer paddles and whip around, possibly injuring the operator.**

# OPERATING INSTRUCTIONS (continued)

## DUMPING

---

Disengage the PTO before dumping. **Never attempt to dump the mixer with the mixer running – PTO damage will result.** Always dump the mixer slowly to avoid splashing the mixture. Be careful not to let the mixer dump too far and bind the hydraulic cylinder. Use a shovel to remove the last of the mixture.



## MAINTENANCE

---



**Before servicing the machine, disengage the PTO, engage the parking brake or place the transmission in "Park," shut off the tractor and remove the key.**

**Keep clear of rotating parts; stay on tractor seat until all motion has stopped.**

**Do not get under machine to make adjustments without securely blocking implement first.**

If work is required while the mixer is attached to the tractor, the mixer must be blocked securely. NEVER trust the tractors' hydraulic system.

After mixing concrete, or any material that clings to the side of the drum, be sure to clean thoroughly when finished. In mixing concrete, if there are lapses between batches, it is a good idea to add some water and rinse so that the concrete will not set in the drum.

Thoroughly clean the grease zerks before servicing. Dirt mixed with lubricant will rapidly wear parts and destroy bearings.

Check the drive chain and if necessary, adjust with the tightener.

Carefully check and replace any worn or damaged parts.

## TRANSPORTING

---



**When traveling on public roads, whether at night or during the day, use accessory light and devices for adequate warnings to operators of other vehicles. Comply with all federal, state and local laws.**

- Be sure to reduce tractor ground speed when turning; and, leave enough clearance so the mixer does not contact obstacles such as buildings, trees or fences.
- Select a safe ground travel speed when transporting from one area to another. When traveling on roadways, transport in such a way that faster moving vehicles may pass you safely.
- When traveling over rough or hilly terrain, slow down and use extra care.
- Read all the safety warnings in the front of the manual.

## STORAGE

---

- At the end of the working season or when the mixer will not be used for a long period, it is good practice to clean off any dirt or grease that may have accumulated on any of the moving parts.
- Store mixer in a dry location. If mixer must be stored outside, place drum so that the mouth of the drum is down to prevent water from accumulating in the drum.
- Make sure the hydraulic toplink cylinder has the rod end fully retracted into the cylinder body and that the breather hole on the cylinder body is positioned where water cannot enter. (It is recommended that the hydraulic toplink cylinder be stored inside.)
- Inspect the mixer for loose, damaged or worn parts and adjust or replace if needed.
- Lubricate as noted.
- Collapse driveshaft as far as possible and store it to prevent ground contact. Place blocks under mixer skids.
- Sand areas where paint is chipped or worn and repaint to prevent rust.
- Always store in a safe place away from children or livestock.

# TROUBLE - SHOOTING

---

## **PROBLEM: MIXER DUMPS AND WON'T COME BACK TO LOAD POSITION**

### POSSIBLE SOLUTIONS:

- ❖ Hydraulic hose from cylinder not connected to tractor hydraulic remote outlet.
- ❖ Hydraulic topline cylinder on mixer is single acting and is incompatible with tractor remote outlet valve – check manual and tractor dealer to see if different valve is available.
- ❖ Low oil in tractor reservoir – add oil.
- ❖ Front of tractor is headed downhill and oil level in reservoir is low – add oil.

## **PROBLEM: MIXER WILL NOT DUMP**

### POSSIBLE SOLUTIONS:

- ❖ Hydraulic topline not connected properly to tractor hydraulic outlet.
- ❖ Tractor hydraulic valve not working properly – check tractor manual.
- ❖ Low oil level in tractor hydraulic reservoir – check oil level.
- ❖ See – Mixer Not Tilting Enough Section and Mixer Dumps And Won't Come Back Section.

## **PROBLEM: MIXER WILL NOT TILT ENOUGH WHEN DUMPING**

### POSSIBLE SOLUTIONS:

- ❖ Geometry of pull pin location and topline is not correct – change location of topline connection to mixer and location of pull pins.
- ❖ Low profile tractor being used – use different tractor.
- ❖ Tractor front end is positioned downhill at dumping site – dump mix on level ground into wheelbarrow and transport to actual dump site.

## **PROBLEM: DRIVE CHAIN BREAKS**

### POSSIBLE SOLUTIONS:

- ❖ Loading mixer while drum is stationary and then trying to start a loaded drum to turn – always load into a turning mixer.
- ❖ Using a tractor without live PTO and having to stop/start mixer drum when shifting tractor gears. Use another tractor or mix less material for less load.
- ❖ Too much load for mixer – reduce amount of material.
- ❖ Drive chain not properly tightened.
- ❖ Drive chain is rusted and has been setting outside – replace chain and lubricate regularly.
- ❖ Tractor engine RPM too high when engaging PTO – always slow engine RPM when engaging or disengaging PTO.

## **PROBLEM: MIXER SHAKES EXCESSIVELY**

### POSSIBLE SOLUTIONS:

- ❖ Stabilizer straps not attached to tractor 3 pt. hitch lift arms – install stabilizer.
- ❖ Mix too dry and has formed a clump – add water.
- ❖ Material has large chunks – break up material before putting in mixer drum.
- ❖ Tractor engine idle too slow – increase engine RPM slightly.
- ❖ PTO driveline is operating at a severe angle – raise or lower 3 pt. hitch so driveline is operating with minimum angle.

MODEL 580 MIXER PARTS VIEW

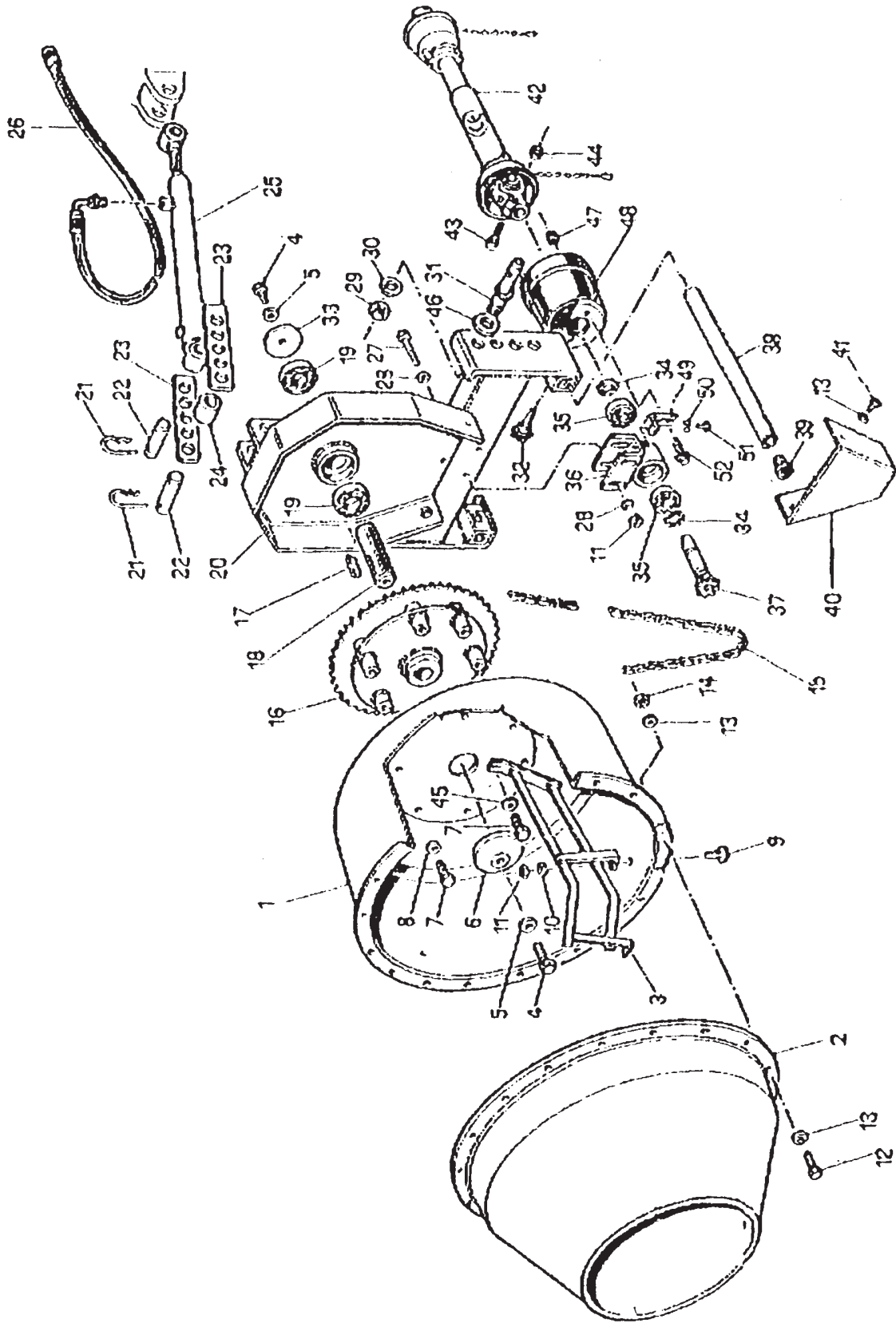

## MODEL 580 MIXER PARTS LIST

Ref. No.	Workshop Part No.	Description	AGR Code No.	No. Req'd.
1	780621	Drum, Main	BM32001	1
2	780622	Drum, Cone	BM32002	1
3	780623	Paddle, Mixing	BM32014	3
4	2503277	Bolt, M14 x 30 Gr.8.8 Hex Head	52391430	2
5	2502021	Washer, M14 External Star	1751A14Z	2
6	780627	Washer, Inner	BM32003	1
7	2503269	Bolt, M12 x 25 Gr.8.8 Hex Head	52391225	6
8	2501027	Washer, M12 Flat	659212ZN	3
9	2503269	Bolt, M12 x 25 Gr.8.8 Hex Head	52391225	6
10	2501027	Washer, M12 Flat	659212ZN	6
11	2500086	Nut, M12 Hex	558810ZN	8
12	2503278	Bolt, M8 x 16 Gr.8.8 Hex Head	52390816	18
13	2501029	Washer, M8 Flat	659208ZN	36
14	2500088	Nut, M8 Hex	558808ZN	18
15	780624	Chain, #40 (142 Pitches)	CAT12142	1
16	780625	Sprocket Assembly, Drum	BM32005	1
17	780626	Key, 14 x 9 x 50mm	66040750	1
18	780628	Shaft, Drum	BM32009	1
19	780629	Bearing, Ball 6209-2RS	62092RS0	2
20	780630	Frame	BM32004	1
21	780631	Cotter Pin	80100510	4
22	780632	Pin, Cylinder	BM32012	2
23	780633	Bar, Cylinder Attachment	BM32025	2
24	780634	Bushing, Cylinder	BM3201907	1
25	780635	Cylinder, Hydraulic-Toplink	BM32019	1
26	780636	Hose, Hydraulic	30015075	1
27	2503279	Bolt, M10 x 90 Gr.8.8 Hex Head	52371090	2
28	2502019	Washer M10 x 30	659310ZN	4
29	2500089	Nut, M24 Hex	558824ZF	2
30	2502022	Washer, M24 Springlock	175124ZN	2
31	780637	Pin, Pull	S5051008	2
32	780638	Knob, M8 x 20	VB408150	2
33	780639	Washer, Drum Shaft Retainer	BM32008	1
34	780640	Snap Ring, E D 30	74353000	2
35	780641	Bearing, Ball 6200-2RS	62062RS0	2
36	780642	Support, Drive Shaft	BM32006	1
37	780643	Shaft, Drive w/Sprocket	BM32007	1
38	780644	Tube, Stand	BM32010	2
39	780645	Plug, Stand Tube	TCPP3200	2
40	780646	Guard, Drive Shaft	BM32011	1
41	2503278	Bolt, M8 x 16 Gr.8.8 Hex Head	52390816	2
42	780647	PTO Shaft 'CE' Standard	C31700CE1	1
43	2503280	Bolt, M10 x 50 Socket Head	59321050	1
44	2500090	Nut, M10 Nylock Hex	747310ZN	1
45	2501027	Washer, M12 x 30 Flat	659312ZN	3
46	2501026	Washer, M24 Flat	659224ZN	2
47	2500091	Nut, M8 Whiz Flange Hex	559006ZN	2
48	780648	Guard, PTO	BM32030	1
49	780649	Support, PTO Guard	BM32015	2
50	2501029	Washer, M8 Flat	659208ZN	2
51	2503278	Bolt, M8 x 16 Gr.8.8 Hex Head	52390816	2
52	2503281	Bolt, M8 x 20 Gr.8.8 Hex Head	52390820	2
N/S	780776	Masterlink, #40 Chain		1

# ⚠ SAFETY PRECAUTIONS ⚠

**MOST ACCIDENTS OCCUR BECAUSE OF NEGLIGENCE OR CARELESSNESS.  
AVOID NEEDLESS ACCIDENTS BY FOLLOWING ALL OF THE SAFETY PRECAUTIONS LISTED BELOW.**

- Machinery should be operated only by those who are responsible and are authorized to do so.
- Stop the engine, lower all equipment, lock the brakes, and remove the ignition key before dismounting from the tractor.
- Never stand between tractor and implement while tractor is being backed to hitch.
- Loose fitting clothing should not be worn, to avoid catching on various parts.
- Detach implement in area where children normally do not play.
- When performing adjustments or maintenance on an implement, first lower it to the ground or block it securely at a workable height.
- Only a qualified operator should be permitted on tractor when in operation; no riders allowed.
- Make certain everyone is in the clear before starting tractor or raising or lowering equipment.
- Operate the tractor and implement only while seated in the driver's seat.
- Reduce speed when transporting mounted implements to avoid bouncing and momentary loss of steering control.
- A heavy load can cause instability of the tractor. Use extreme care during road travel. Slow down on turns and watch out for bumps. Tractor may need front counterweights to counter-balance the weight of the implement.
- Reduce speed on hillsides or curves so there is no danger of tipping.
- Avoid driving too close to the edge of ditches or creeks.
- Do not transport implement on public roads without reflectors and slow moving vehicle emblem in daylight and with approved warning lights at night and other periods of poor visibility.
- Due to the width of some implements, use extra caution on highways, farm roads, and when approaching gates.
- Always be sure the implement is in the proper position for transport.
- Keep alert and watch the front as well as the rear when working with the implement.

## OWNER'S MANUAL

**MODEL NO.  
580**

APRIL 2000

## 3 PT. MIXER

**WHEN ORDERING REPAIR PARTS,  
ALWAYS GIVE THE  
FOLLOWING INFORMATION:**

1. PART NUMBER
2. PART DESCRIPTION
3. MODEL NUMBER
4. NAME OF ITEM

**MAKE EVERY DAY  
A HOLIDAY  
FROM ACCIDENTS!**

**WORKSAVER, INC.**

**P.O. BOX 100 LITCHFIELD, IL 62056-0100 (217) 324-5973  
WEB: <http://www.worksaver.com> E-MAIL: [sales@worksaver.com](mailto:sales@worksaver.com)**